

Elevation - A

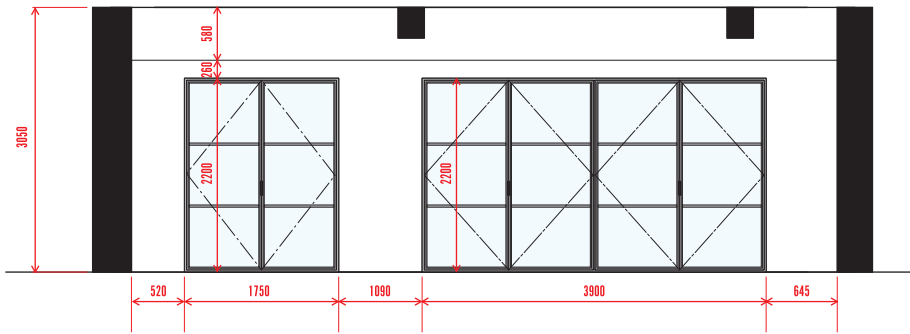

Elevation - B

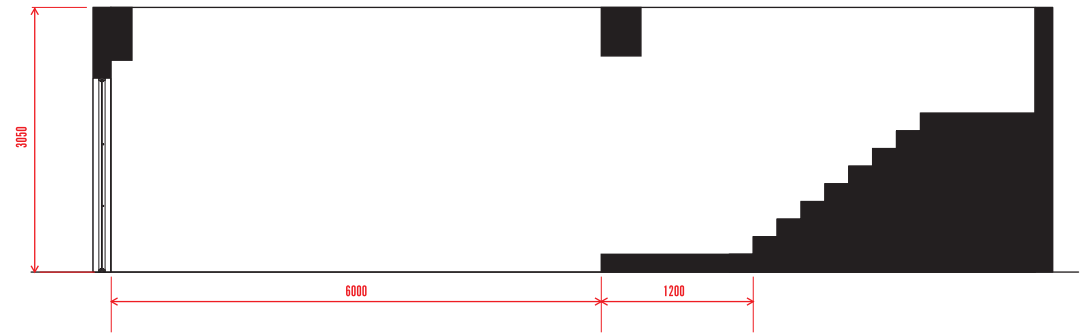

Elevation - C

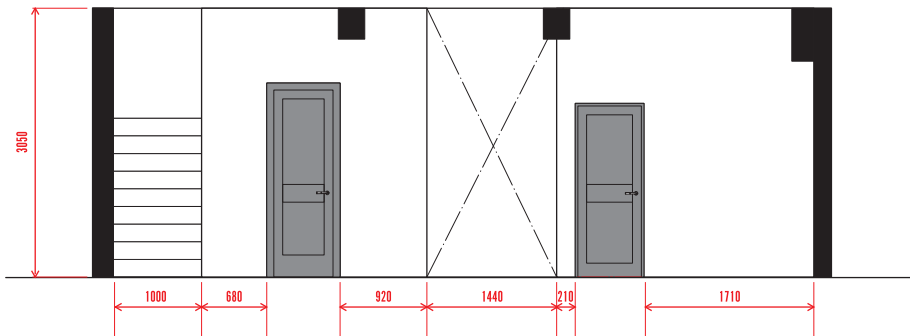

Elevation - D

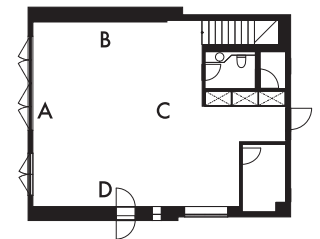
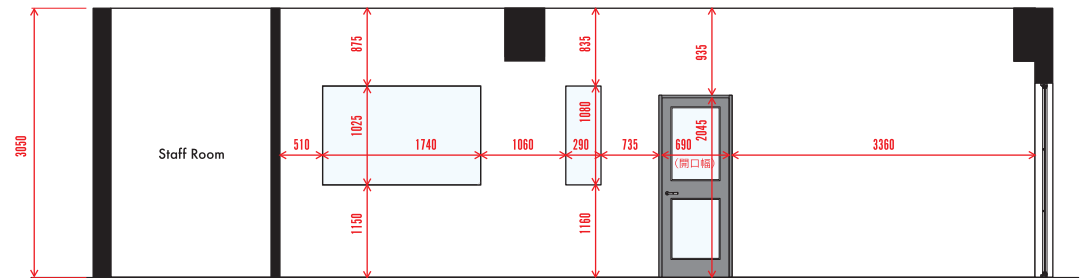

Elevation - A

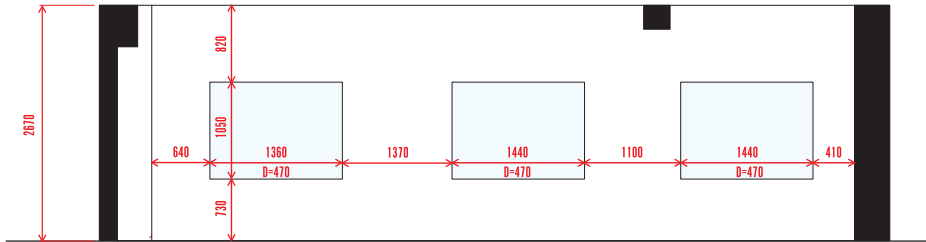

Elevation - B



Elevation - C

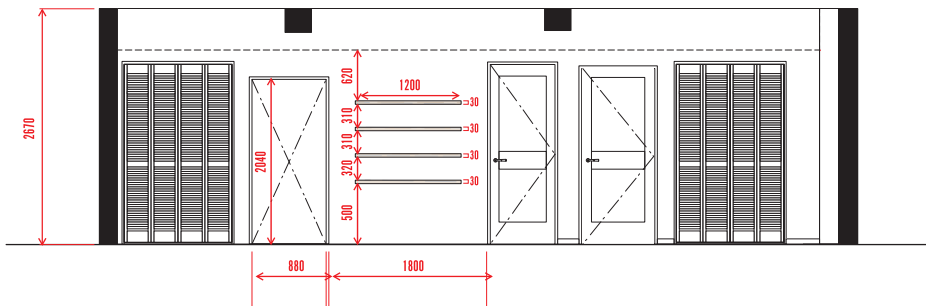

Elevation - D

